

LSAK 型经济型接线端子

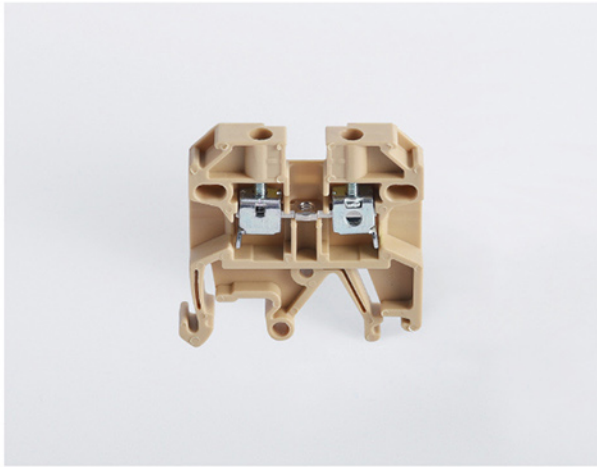

CE RoHS

LSAK 2.5EN

24A 800V IEC 60947-7-1



额定横截面: 0.2-2.5mm²

连接类型: 螺钉

端子尺寸: 厚6.1×高40.4×宽40.9mm

认证: UL 94 V0

参数

(1)端板: 厚1.5mm	AP 2.5	
(2)中心联连件: 10位, 可分2位, 3位, 4位	2.5 EN, Q2位, 3位, 10位	
(3)通用终端固定件	LEW 35	
(4)印字连续标记条	DEK 5/6(1...10)	

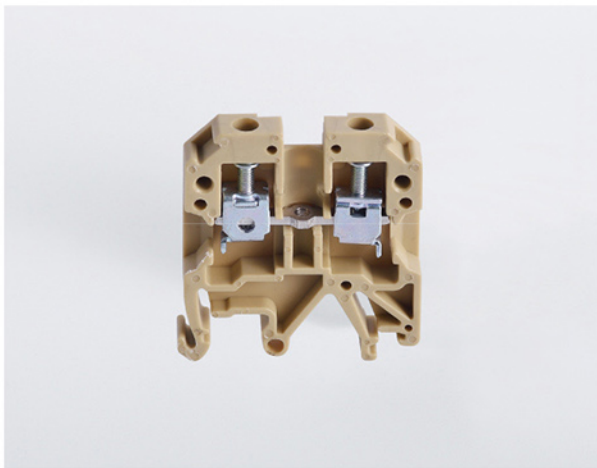

CE RoHS

LSAK 4EN

32A 800V IEC 60947-7-1



额定横截面: 0.2-4mm²

连接类型: 螺钉

端子尺寸: 厚6.5×高45.3×宽40.6mm

认证: UL 94 V0

参数

(1)端板: 厚1.5mm	AP 4-10	
(2)中心联连件: 10位, 可分2位, 3位, 4位	4 EN, Q2位, 3位, 10位	
(3)通用终端固定件	LEW 35	
(4)印字连续标记条	DEK 6(1...10)	





CE RoHS

LSAK 6EN

41A 800V IEC 60947-7-1

额定横截面: 0.2-6mm²
 连接类型: 螺钉
 端子尺寸: 厚7.9×高45×宽39.9mm
 认证: UL 94 V0

参数

(1)端板: 厚1.5mm	AP 4-10	
(2)中心联连件: 10位, 可分2位, 3位, 4位	6 EN, Q2位, 3位, 10位	
(3)通用终端固定件	LEW 35	
(4)印字连续标记条	DEK 6(1...10)	

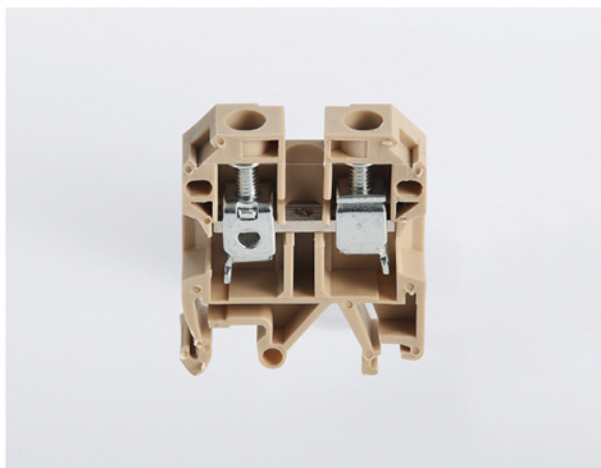



CE RoHS

LSAK 10EN

57A 800V IEC 60947-7-1

额定横截面: 0.5-10mm²
 连接类型: 螺钉
 端子尺寸: 厚10×高45.2×宽40.5mm
 认证: UL 94 V0

参数

(1)端板: 厚1.5mm	AP 4-10	
(2)中心联连件: 10位, 可分2位, 3位, 4位	10 EN, Q2位, 3位, 10位	
(3)通用终端固定件	LEW 35	
(4)印字连续标记条	DEK 6(1...10)	

LSAK 型经济型接线端子

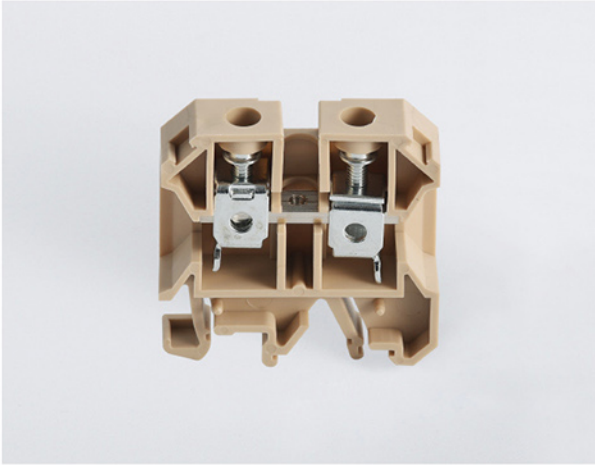

CE RoHS

LSAK 16EN

76A 800V IEC 60947-7-1



额定横截面: 0.5-16mm²

连接类型: 螺钉

端子尺寸: 厚12×高51.2×宽50.3mm

认证: UL 94 V0

参数

(1)端板: 厚1.5mm	AP 16	
(2)中心联连件: 10位, 可分2位, 3位, 4位	16 EN, Q2位, 3位, 10位	
(3)通用终端固定件	LEW 35	
(4)印字连续标记条	DEK 5/6(1...10)	

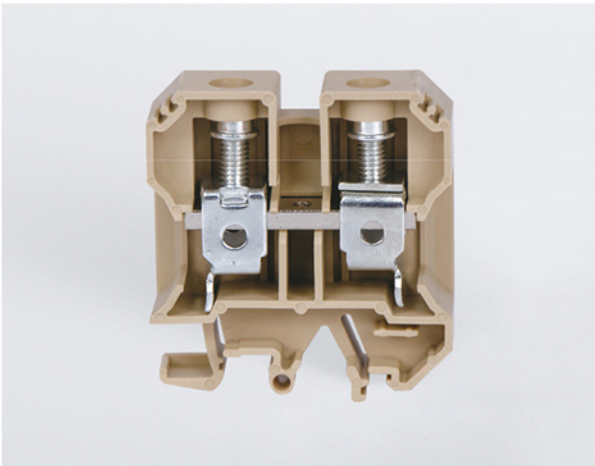

CE RoHS

LSAK 35EN

125A 800V IEC 60947-7-1



额定横截面: 10-35mm²

连接类型: 螺钉

端子尺寸: 厚18.2×高61.6×宽58.5mm

认证: UL 94 V0

参数

(1)端板: 厚1.5mm	AP 35	
(2)中心联连件: 10位, 可分2位, 3位, 4位	35 EN, Q2位, 3位, 10位	
(3)通用终端固定件	LEW 35	
(4)印字连续标记条	DEK 6(1...10)	

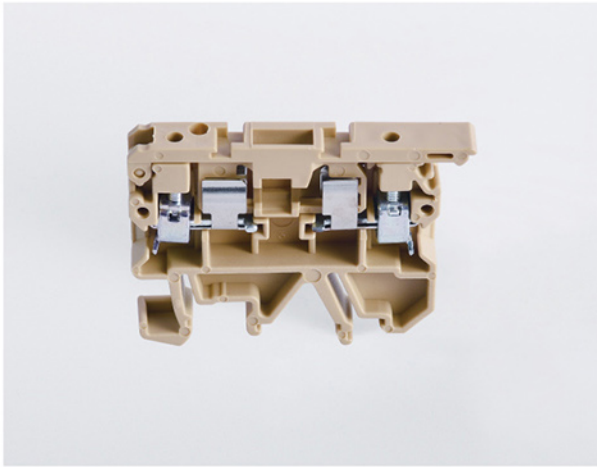

LASK1 EN

6.3A 500V IEC 60947-7-1

额定横截面: 0.2-4mm²



连接类型: 螺钉

端子尺寸: 厚8.1×高39×宽52.1mm

认证: UL 94 V0

CE RoHS

参数

(1) 端板: 厚1.5mm	AP-LASK1	
(3) 通用终端固定件	LEW 35	
(4) 印字连续标记条	DEK 6(1...10)	



EK 型经济型接地端子

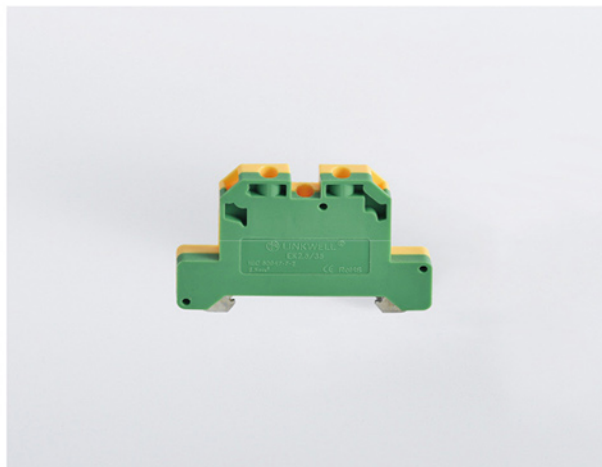

CE RoHS

EK 2.5/35

IEC 60947-7-1

额定横截面: 0.2-2.5mm²

连接类型: 螺钉

端子尺寸: 厚6.6×高36.5×宽56.5mm

认证: UL 94 V0



CE RoHS

EK 4/35

IEC 60947-7-1

额定横截面: 0.2-4mm²

连接类型: 螺钉

端子尺寸: 厚6.6×高40.3×宽57.4mm

认证: UL 94 V0



CE RoHS

EK 6/35

IEC 60947-7-1

额定横截面: 0.2-6mm²

连接类型: 螺钉

端子尺寸: 厚8×高40.4×宽57.1mm

认证: UL 94 V0



CE RoHS

EK 10/35

IEC 60947-7-1

额定横截面: 0.5-10mm²

连接类型: 螺钉

端子尺寸: 厚10×高40.3×宽56.8mm

认证: UL 94 V0



CE RoHS

EK 16/35

IEC 60947-7-1

额定横截面: 0.5-16mm²

连接类型: 螺钉

端子尺寸: 厚12×高46.5×宽57.2mm

认证: UL 94 V0



CE RoHS

EK 35/35

IEC 60947-7-1

额定横截面: 10-35mm²

连接类型: 螺钉

端子尺寸: 厚16×高56.6×宽58.6mm

认证: UL 94 V0

JXB 型经济型接线端子

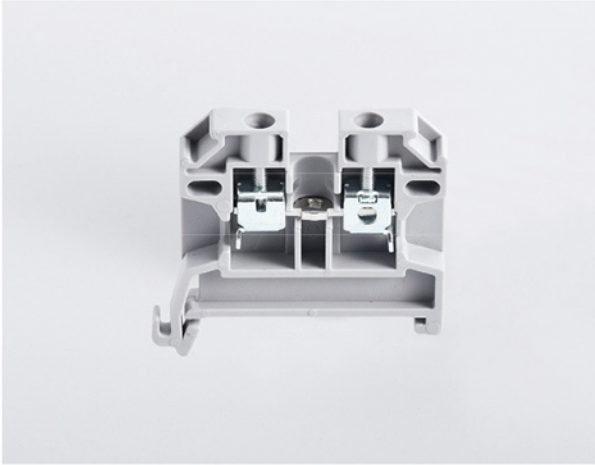

CE RoHS

JXB-2.5/35

26A 750V IEC 60947-7-1



额定横截面: 0.2-2.5mm²

连接类型: 螺钉

端子尺寸: 厚6.2×高40.5×宽44.8mm

认证: UL 94 V0

参数

(1)端板: 厚1.5mm	JXB-2.5/35G	
(2)中心联连件: 10位, 可分	2-10位	
(3)通用终端固定件	GD 35	
(4)印字连续标记条	DEK 5/6	



CE RoHS

JXB-4/35

34A 750V IEC 60947-7-1



额定横截面: 0.2-4mm²

连接类型: 螺钉

端子尺寸: 厚6.4×高43.7×宽44.5mm

认证: UL 94 V0

参数

(1)端板: 厚1.5mm	JXB-4/10G	
(2)中心联连件: 10位, 可分	JXB-4L, 2位-10位	
(3)通用终端固定件	GD 35	
(4)印字连续标记条	DEK 6印字	

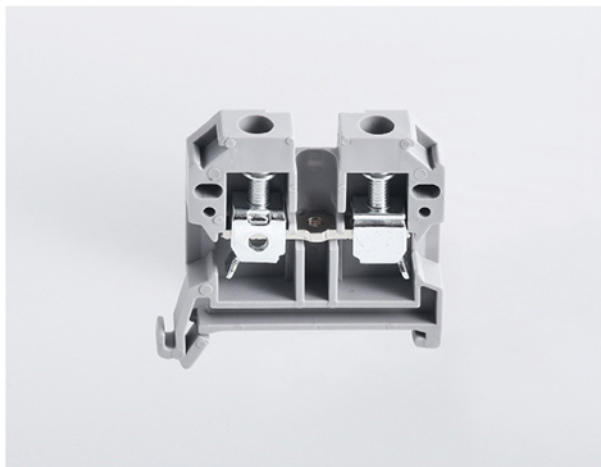



CE RoHS

JXB-6/35

44A 750V IEC 60947-7-1

额定横截面: 0.2-6mm²
 连接类型: 螺钉
 端子尺寸: 厚7.8×高43.6×宽44.6mm
 认证: UL 94 V0

参数

(1)端板: 厚1.5mm	JXB-4/10G	
(2)中心联连件: 10位, 可分	JXB-6L, 2位-10位	
(3)通用终端固定件	GD 35	
(4)印字连续标记条	DEK 6印字	

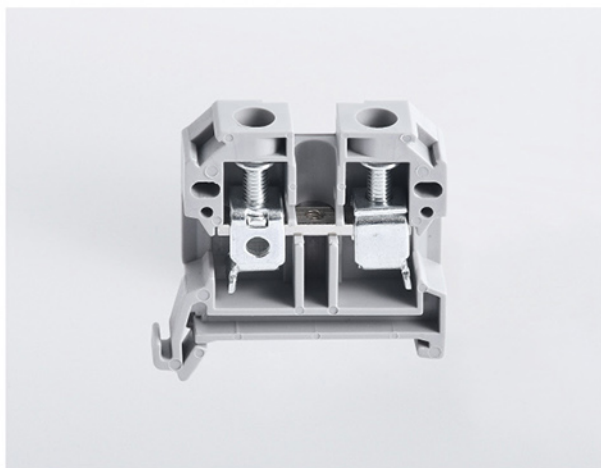



CE RoHS

JXB-10/35

76A 750V IEC 60947-7-1

额定横截面: 0.5-16mm²
 连接类型: 螺钉
 端子尺寸: 厚12×高51.5×宽50.5mm
 认证: UL 94 V0

参数

(1)端板: 厚1.5mm	JXB-16/35G	
(2)中心联连件: 10位, 可分	JXB-16L, 2位-10位	
(3)通用终端固定件	GD 35	
(4)印字连续标记条	DEK 6印字	

JXB 型经济型接线端子

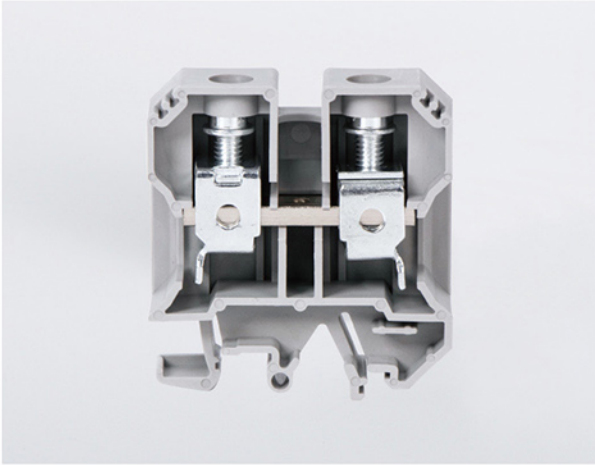

CE RoHS

JXB-35/35

125A 750V IEC 60947-7-1



额定横截面: 10-35mm²

连接类型: 螺钉

端子尺寸: 厚18×高61.4×宽58.4mm

认证: UL 94 V0

参数

(1)端板: 厚1.5mm	JXB-35/35G	
(2)中心联连件: 10位, 可分	JXB-35L, 2位-10位	
(3)通用终端固定件	GD 35	
(4)印字连续标记条	DEK 5/6	



CE RoHS

JXB-RD

6.3A 500V IEC 60947-7-1



额定横截面: 0.2-4mm²

连接类型: 螺钉

端子尺寸: 厚8.1×高42.4×宽58.1mm

认证: UL 94 V0

参数

(1)端板: 厚1.5mm	JXB-RDG	
(2)中心联连件: 10位, 可分	-	
(3)通用终端固定件	GD 35	
(4)印字连续标记条	DEK 5/6	